

# **AWT100 Data Conversion Module**

## **Installation Manual V1.2**

**Acrel Co., Ltd.**

# **DECLARATION**

All rights reserved. Without the written permission of the company, the contents of any paragraphs and chapters in this manual shall not be excerpted, copied or copied or disseminated in any form, otherwise all consequences shall be borne by the offender.

The company reserves the right to modify the product specifications described in the manual without notice. Before placing an order, please consult your local agent for the new specifications of this product.

## Contents

1 Overview.....	1
2 Product Model.....	2
3 Features.....	2
4 Typical Applications.....	3
5 Technical Parameters.....	3
6 Installation and wiring instructions.....	5
6.1 Outline and installation dimensions.....	5
6.2 Product installation Adopt standard DIN35mm rail type installation.....	6
6.3 Terminals and wiring.....	6
6.3.1 AWT100-2G/NB/4G/LoRa/LW/GPS/WiFi terminal and wiring.....	6
6.3.2 AWT100-CE terminal and wiring.....	6
6.3.3 AWT100-DP terminal and wiring.....	6
6.3.4 AWT100-2G/NB/4G/LoRa/LW/GPS/WiFi/CE/DP side interface definition.....	7
6.4 Panel light definition.....	8
6.4.1 Definition of AWT100-2G/NB/4G wireless communication terminal panel lights.....	8
6.4.2 Definition of AWT100-LoRa wireless communication terminal panel light.....	8
6.4.3 AWT100-LW Definition of wireless communication terminal panel lights.....	9
6.4.4 AWT100-GPS Definition of wireless communication terminal panel lights.....	9
6.4.5 AWT100-WiFi Definition of wireless communication terminal panel lights.....	9
6.4.6 AWT100-CE Ethernet communication panel light definition.....	9
6.4.7 AWT100-DP data conversion module panel light definition.....	9
6.4.8 AWT100-POW Panel light definition of power module.....	9
7 AWT100 Wireless Communication Terminal User Guide.....	9
7.1 AWT100 wireless communication terminal configuration.....	9
7.2 AWT100 wireless communication terminal parameter description.....	11
8 How to use.....	17

## 1 Overview

At present, wireless technology relies on the advantages of easy deployment, low construction cost, and wide application environment. Data diversification has gradually become an important direction for network development and application in the future industrial Internet. AWT100 data conversion module is a new data conversion DTU launched by Acrel Electric. Communication data conversion includes 2G, 4G, NB, LoRa, LoRaWAN, GPS, WiFi, CE, DP and other communication methods. The downlink interface provides a standard RS485 data interface. It can be easily connected to power meters, RTUs, PLCs, industrial computers and other equipment, and only needs to complete the initial configuration at a time to complete the data collection of the MODBUS equipment; at the same time, the AWT100 series of wireless communication terminals use powerful micro-processing chips to cooperate Built-in watchdog technology, reliable and stable performance.

The appearance is shown in Figure 1.



Figure 1 AWT100 Wireless communication terminal

Features:

- Using single-mode guide rail shape, small size, flexible and convenient installation;
- A variety of mainstream wireless modules, suitable for various on-site environments;
- Multiple hardware interface modes, easy to use with other products;
- Rich communication interface protocols can meet the different needs of customers.

The applicable industries are as follows:

- Wireless meter reading;
- Building automation and security;
- Robot control;
- Power distribution network monitoring, power load monitoring;
- Intelligent lighting control;
- Automatic data collection;
- Industrial remote control and telemetry;
- Highway and railway data transmission;
- Other power and industrial control industries, etc.

## 2 Product Model

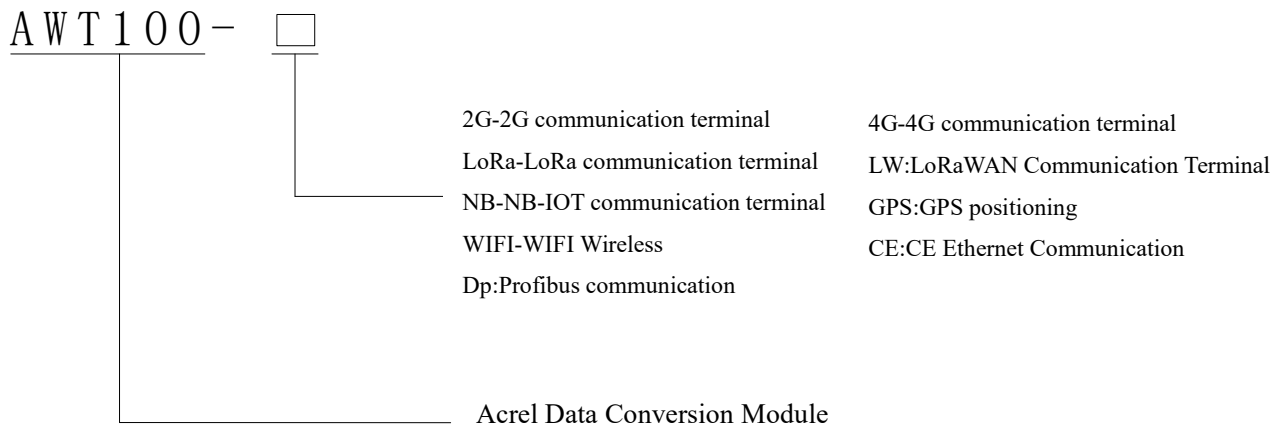

## 3 Features

- Support serial MODBUS RTU protocol data collection, and communicate with Acrel server through Acrel platform protocol①.
- Support data collection of up to 30 MODBUS RTU devices.
- Support the collection of 5 register address fields for each MODBUS device, and the address range of each register does not exceed 64.
- Support to preset alarm address and alarm value to trigger alarm for each MODBUS address range. There are currently at most 5 alarm addresses in each address domain.
- Support server MODBUS or LoRa transparent transmission communication.
- Support fixed IP and dynamic domain name resolution methods to connect to the data center.
- Support transparent transmission protocol, general mode (active round copy, regular report), MQTT protocol, smart power wireless protocol, prepaid wireless protocol It can be customized and developed.
- AWT100-LW wireless communication terminal can upload data to the server through LoRa communication.
- AWT100-GPS wireless module can measure geographic location, obtain latitude and longitude and satellite time.
- The AWT100-WiFi wireless module can automatically access the WIFI hotspot according to the hotspot name and password, realize the transparent transmission of 485 and WIFI data, and also use our cloud platform protocol.
- AWT100-CE can realize data transmission from 485 to Ethernet. It can be used as a TCP client and supports transparent transmission or our cloud platform protocol.
- AWT100-DP can realize data transmission from ProfiBus to MODBUS.

Note: ①AWT100-2G/NB/4G wireless communication terminal can communicate with the Acrel server through the Acrel platform protocol.

## 4 Typical Applications

Typical application connections are shown in Figure 2 and Figure 3. Connect the on-site 485 devices to the AWT100 wireless communication terminal. The AWT100 wireless communication terminal will actively collect the data of the 485 device according to its own configuration, and then communicate with the Acrel server.

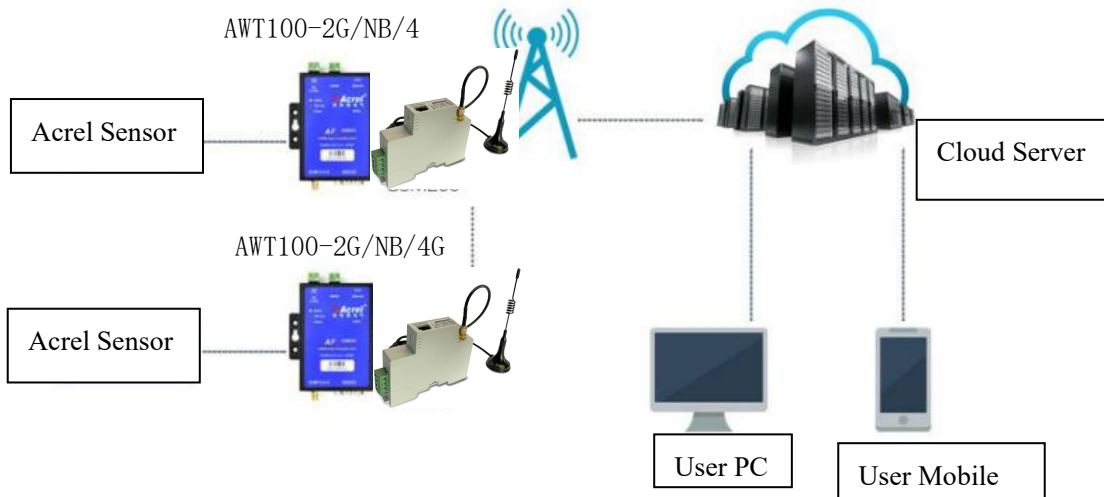

Figure 2 AWT100-2G/NB/4G Typical application of wireless communication terminal

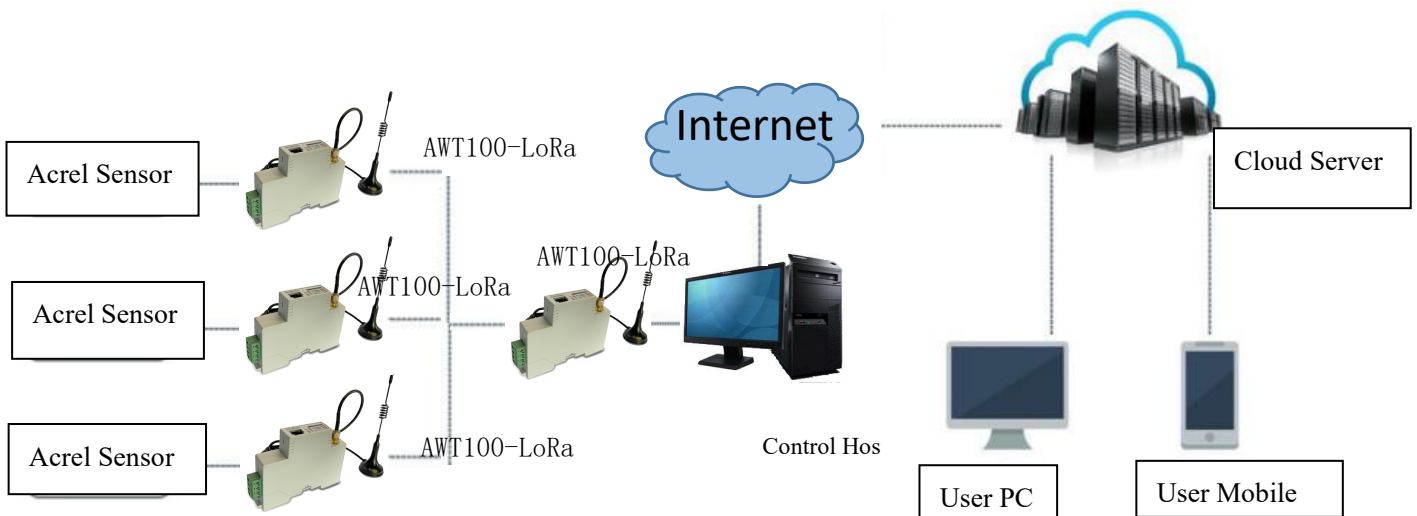

Figure 3 AWT100-LoRa Typical application of wireless communication terminal

## 5 Technical Parameters

Parameter Name	AWT100-4G	AWT100-NB	AWT100-2G	AWT100-LoRa AWT100-LW
Working frequency	LTE-FDD B1 B3 B5 B8 LTE-TDD B34 B38 B39 B40 B41 CDMA B1 B5 B8 GSM 900/1800M	H-FDD B1 B3 B8 B5 B20	GSM 850 EGSM 900 DCS 1800 PCS 1900	LoRa 460 510MHz

Transmission rate	LTE-FDD Maximum downlink rate 150Mbps Maximum uplink rate 50Mbps LTE-TDD Maximum downlink rate 130Mbps Maximum uplink rate 35Mbps CDMA Maximum downlink rate 3.1Mbps Maximum uplink rate 1.8Mbps GSM Maximum downlink rate 107Kbps Maximum uplink rate 85.6Kbps	Maximum downlink rate 25.2Kbps Maximum uplink rate 15.62Kbps	GPRS Maximum downlink rate 85.6kbps Maximum uplink rate 85.6kbps	LoRa 62.5kbps
Downlink	RS485 Communication			
Uplink	4G Communication	NB-IoT Communication	2G Communication	LoRa Communication
SIM card voltage	3V, 1.8V			/
Working current	Static power: $\leq 1W$ , Transient power consumption: $\leq 3W$			Static power: $\leq 0.5W$ , Transient power consumption: $\leq 1W$
Antenna interface	50Ω/SMA (Faucet)			
Serial port type	RS-485			
Baud rate	4800bps、9600bps、19200bps、38400bps (default 9600bps)			
Operating Voltage	DC24V 或 AC/DC220V <sup>①</sup>			
Operating temperature	-10°C~55°C			
Storage temperature	-40°C~85°C			
Humidity range	0~95% Non-condensing			

Parameter Name	AWT100-LoRa	AWT100-LW	AWT100-LW868	AWT100-LW923	AWT100-LORAHW
Working frequency	460~510MHz	470MHz	863-870MHz	920-928MHz	860-935MHz
Transmission rate	LoRa 62.5kbps				
Downlink	RS485 Communication				
Uplink	LoRa Communication				
Working current	Static power: $\leq 0.5W$ , Transient power consumption: $\leq 1W$				
Antenna interface	50Ω/SMA (Faucet)				
Serial port type	RS-485				
Baud rate	4800bps、9600bps、19200bps、38400bps (default 9600bps)				
Operating Voltage	DC24V 或 AC/DC220V <sup>①</sup>				
Operating temperature	-10°C~55°C				

Storage temperature	-40°C~85°C
Humidity range	0~95% Non-condensing

parameter name	AWT100-GPS	AWT100-WiFi	AWT100-CE	AWT100-DP
Work	Positioning accuracy: 2.5-5m	support 2.4G frequency band WiFi rate: 115200bps	Ethernet rate 10/100M adaptive	Profibus address: 1~125. (Note)
Downlink	RS485 Communication			
Uplink	GPS positioning	WiFi wireless	Ethernet communication	Profibus communication
Working current	Static power consumption: ≤1W, transient power consumption: ≤3W			Static power consumption: ≤0.5W, transient power consumption: ≤1W
interface	50Ω/SMA (Faucet)		RJ45	DP9
Serial port type	RS-485 Communication			
Baud rate	4800bps、9600bps、19200bps、38400bps (Default 9600bps)			
Operating Voltage	DC24V or AC/DC220V <sup>①</sup>			
Operating temperature	-10°C~55°C			
Storage temperature	-40°C~85°C			
Humidity range	0~95% Non-condensing			

Note: ①AC/DC220V power supply requires external AWT100-POW power supply module.  
 ②Profibus communication rate: 9.6kbps, 19.2kbps, 45.45kbps, 93.75kbps, 187.5kbps, 500kbps, 1.5Mbps, 3Mbps, 6Mbps, 12Mbps. Data exchange length: total input length≤224 bytes, total output length≤224 bytes. The number of downstream instruments connected: 1~80.

## 6 Installation and wiring instructions

### 6.1 Outline and installation dimensions

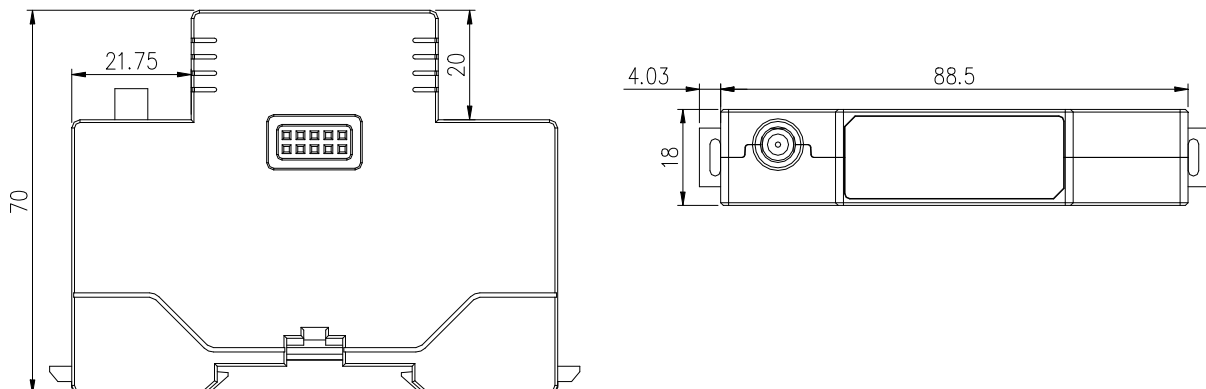



## 6.2 Product installation

Adopt standard DIN35mm rail type installation.

## 6.3 Terminals and wiring

### 6.3.1 AWT100-2G/NB/4G/LoRa/LW/GPS/WiFi terminal and wiring

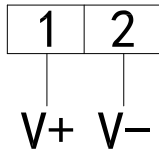

Auxiliary power (DC24V)

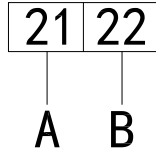

RS485 Communication

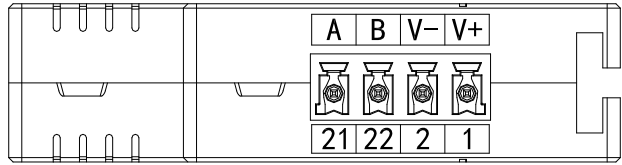

The function of the network port is the power interface and the RS485 interface. The specific definitions are as follows:

1	2	3	4	5	6	7	8
POWER (DC12V)		GND		TX	RX	485A	485B

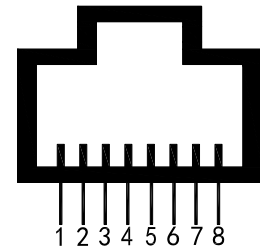

### 6.3.2 AWT100-CE terminal and wiring

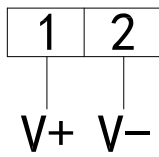

Auxiliary power

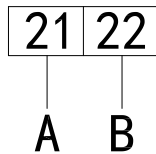

RS485 Communication

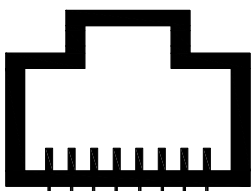
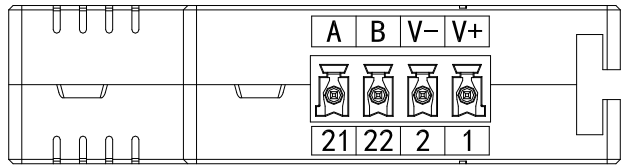

Ethernet communication

### 6.3.3 AWT100-DP terminal and wiring

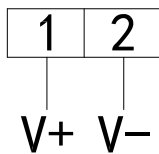

Auxiliary power

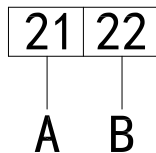

RS485 Communication

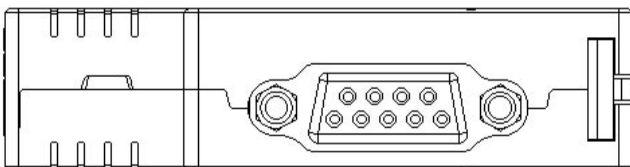
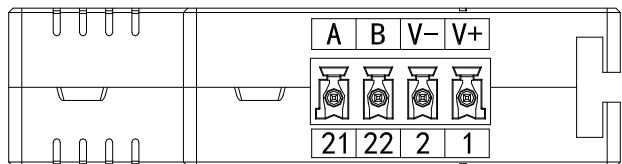

### 6.3.4 AWT100-2G/NB/4G/LoRa/LW/GPS/WiFi/CE/DP side interface definition

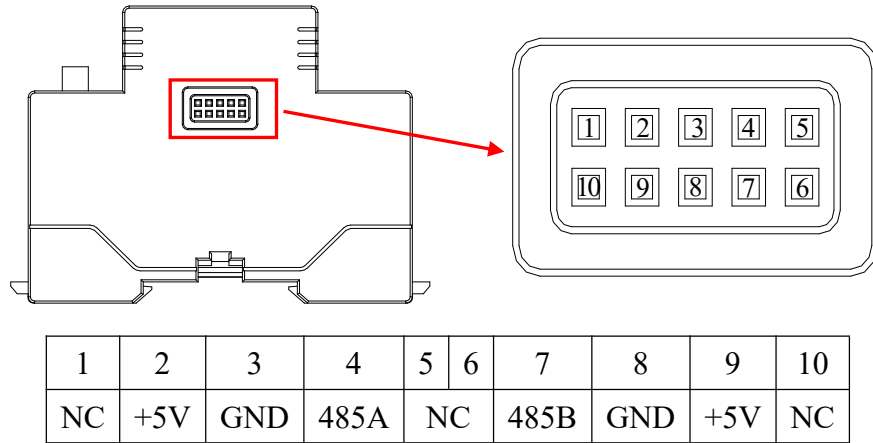

Note: The two interfaces of network port and terminal can only be used by one of the two (except for AWT100-CE), and cannot be used at the same time.

#### Power module terminal definition

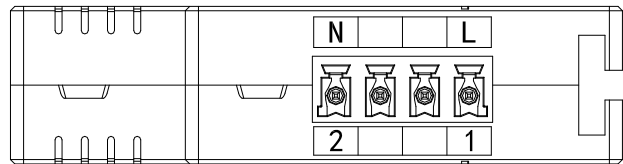
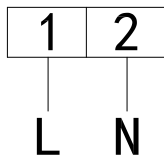

#### Auxiliary power (AC/DC 220V)

#### Side interface definition

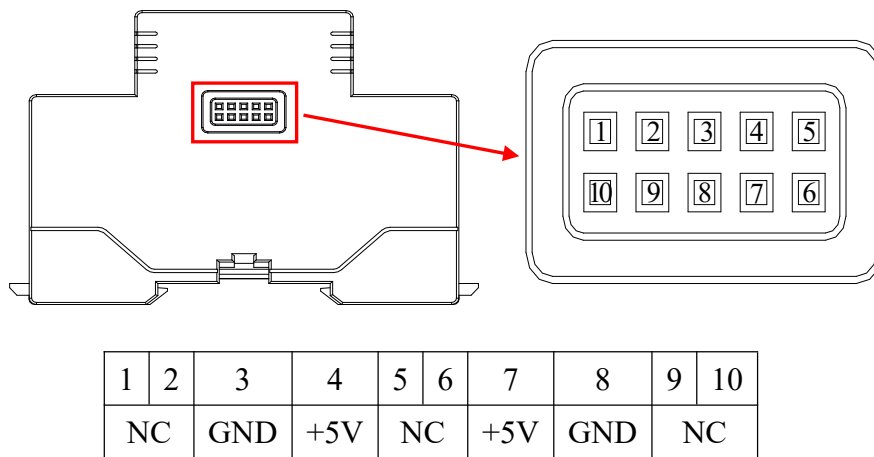

The side interface is used for the AWT100 wireless communication terminal to supply power through the AWT100-POW power module AC220V. The AWT100 wireless communication terminal is connected to the AWT100-POW power supply module through pins and fixed together by a buckle. The connection diagram is shown in Figure 4:

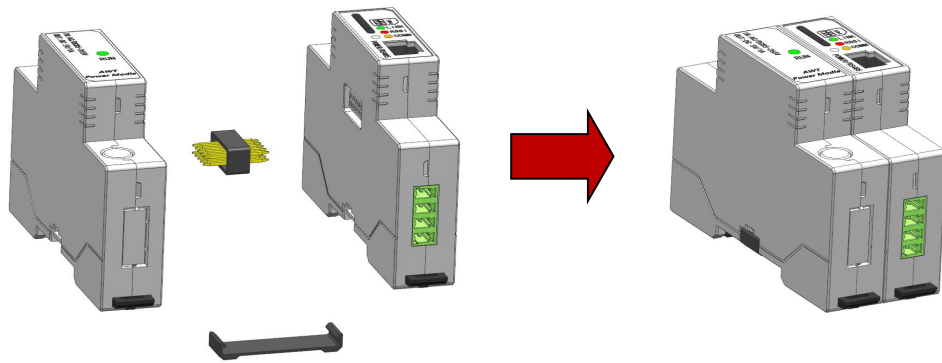

Figure 4

Installation Notes:

- ① When the AWT100 wireless communication terminal is powered by the AWT100-POW power supply module, the auxiliary power terminal and network port of the AWT100 wireless communication terminal The 24V power supply cannot be connected again.
- ② Antenna installation, the antenna interface of the AWT100 wireless communication terminal adopts 50Ω/SMA (female), and the external antenna must be an antenna suitable for the working band. If other unmatched antennas are used, it may affect or even damage the equipment.
- ③ When installing the SIM card, make sure that the device is not powered on. The SIM card of the AWT100 wireless communication terminal adopts a card tray installation method. You need to put the SIM card in the card tray correctly, and then insert the SIM card into the card holder of the device.

6.4 Panel light definition

6.4.1 Definition of AWT100-2G/NB/4G wireless communication terminal panel lights

● LINK (Green)	● RSSI (Red)	● COMM (Orange)
The green indicator flashes for 2 seconds, the wireless module is being initialized	The red indicator flashes for 3 seconds to indicate that the signal is less than 20%	The orange indicator flashes to indicate that there is network data communication
The green indicator flashes for 1 second, connecting to the server		
The green indicator light is always on to indicate that the server is connected and the signal strength is greater than 20%		

6.4.2 Definition of AWT100-LoRa wireless communication terminal panel light

● RUN (Green)	● LoRa (Red)	● COMM (Orange)
The green indicator light is always on, indicating that the meter has been able to operate normally.	The red indicator light flashes for 1 second when there is a LoRa signal to receive and send data.	The orange indicator light flashes for 1 second when there is 485 to receive and send data.

### 6.4.3 AWT100-LW Definition of wireless communication terminal panel lights

● RUN (Green)	● LoRa (Red)	● COMM (Orange)
The green indicator flashes for 1 second and the gateway is connecting.	The red indicator flashes for 1 second when there is LoRa signal to receive and send data.	The orange indicator flashes for 1 second when there is 485 to receive and send data.
The green indicator light is always on to indicate that the gateway has been connected		

### 6.4.4 AWT100-GPS Definition of wireless communication terminal panel lights

● RUN (Green)	● LoRa (Red)
The green indicator light is always on, indicating that the power supply voltage is normal.	After the positioning is successful, it flashes for 1 second and the green indicator light is off

### 6.4.5 AWT100-WiFi Definition of wireless communication terminal panel lights

● RUN (Green)	● LoRa (Red)
Blinking in connection, the connection is successful.	Blinking when there is data transmission

### 6.4.6 AWT100-CE Ethernet communication panel light definition

RJ45: Ethernet interface

### 6.4.7 AWT100-DP data conversion module panel light definition

Digital tube: display Profibus address (1~99)

USB interface: configure the module parameters, connect to the upper computer

DB9 interface: communicate with upstream DP equipment, Profibus\_DP protocol

485 interface: communication with downstream instruments, Modbus\_Rtu protocol

### 6.4.8 AWT100-POW Panel light definition of power module

The green indicator light is always on to indicate that the power module is operating normally. If the indicator light is off, it indicates that the module is not powered on or is faulty.

## 7 AWT100 Wireless Communication Terminal User Guide

### 7.1 AWT100 wireless communication terminal configuration

Before using the AWT100 wireless communication terminal, the user can configure the parameters of the AWT100 wireless communication terminal according to the actual situation. The operation process is as follows:

(1) The AWT100 wireless communication terminal is powered on, and the working indicator of the AWT100 wireless communication terminal flashes, indicating that the AWT100 wireless communication terminal has started to work.

(2) Start the configuration software of the AWT100 wireless communication terminal, which consists

of the computer serial port parameter area, information display area, parameter setting area, parameter reading and setting buttons, as shown in Figure 5.

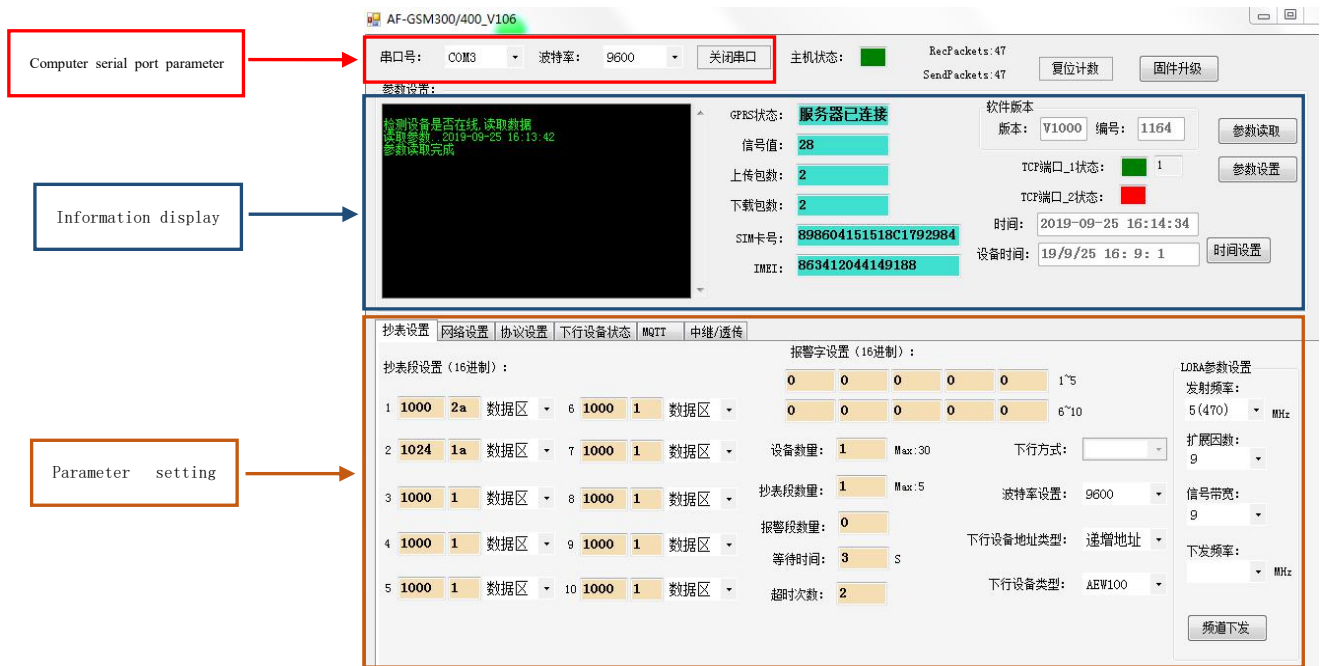

Figure 5

The AWT100 wireless communication terminal configuration software can read and set parameters, and can test the working status of the AWT100 wireless communication terminal. Please confirm the serial port number of the currently used serial port, modify the serial port number, and keep the serial port baud rate consistent, and click "open serial port" after confirmation. After the serial port is successfully connected to the host computer (the host status box turns green) **主机状态: [Green Box]**。

### (3)AWT100-2G/4G/NB wireless communication terminal parameter reading

Click the **参数读取** button in the upper right corner, to display all the parameter values inside the AWT100 wireless communication terminal, as shown in Figure 5.

### (4)AWT100-2G/4G/NB wireless communication terminal parameter setting

Click the parameter value to be modified, directly input or modify the corresponding parameter value, Click the **参数设置** button in the upper right corner to complete the parameter setting.

## 7.2 AWT100 wireless communication terminal parameter description

### (1) AWT100-2G/4G/NB wireless communication terminal connection status



#### ● GPRS status

Display the connection status between the AWT100-2G/4G/NB wireless communication terminal

and the server.

- Signal value

Indicates the signal strength of the connection between the AWT100-2G/4G/NB wireless communication terminal

and the server. The larger the value, the stronger the signal.

- Number of upload packages

Indicates the number of data packets uploaded by the AWT100-2G/4G/NB wireless communication terminal to the server.

- Number of download packages

Indicates the number of data packets received from the server by the AWT100-2G/4G/NB wireless communication terminal.

- SIM card number

Insert the SIM card number of the AWT100-2G/4G/NB wireless communication terminal.

- IMEI

The device identification code of the AWT100-2G/4G/NB wireless communication terminal.

## (2) AWT100 wireless communication terminal software information

软件版本  
版本: V1000 编号: 1164 参数读取  
TCP端口\_1状态: ■ 1 参数设置  
TCP端口\_2状态: ■  
时间: 2019-09-25 16:40:00  
设备时间: 19/9/25 16:34:27 时间设置

- version

Software version of AWT100 wireless communication terminal。

- serial number

Software version of AWT100 wireless communication terminal。

- TCP port\_1 status

■Green indicates that the AWT100-2G/4G/NB wireless communication terminal is successfully connected to the server port. ■Red indicates that the AWT100-2G/4G/NB wireless communication terminal failed to connect to the server port.

- TCP port\_2 status

TCP port\_2 is currently not used。

- Time

The system time of the current computer.

- Equipment time

Equipment time of wireless communication terminal AWT100-2G/4G/NB,Click 时间设置 the device time of the AWT100-2G/4G/NB wireless communication terminal can be synchronized with the current computer system time.

The screenshot shows a configuration window with several tabs: 抄表设置 (selected), 网络设置, 协议设置, 下行设备状态, MQTT, and 中继/透传. The main area is divided into three sections:

- 抄表段设置 (16进制):** A table with 10 rows and 2 columns of input boxes. Each row contains a starting address and a length, followed by a dropdown menu set to '数据区'.
 

1	1000	2a	数据区
2	1024	1a	数据区
3	1000	1	数据区
4	1000	1	数据区
5	1000	1	数据区
6	1000	1	数据区
7	1000	1	数据区
8	1000	1	数据区
9	1000	1	数据区
10	1000	1	数据区
- 报警字设置 (16进制):** A row of 10 input boxes for alarm words, with values 1001, 1002, 1003, 0, 0, 0, 0, 0, 0, 0. Below this are fields for '设备数量' (1), '抄表段数量' (1), '报警段数量' (0), '等待时间' (3s), and '超时次数' (2).
- 下行设备设置:** Fields for '下行方式', '波特率设置' (9600), '下行设备地址类型' (递增地址), and '下行设备类型' (AEW100).
- LoRA参数设置:** Fields for '发射频率' (5(470) MHz), '扩展因数' (9), '信号带宽' (9), and '下发频率'.

- Data area

The first box in the data area indicates the starting MODBUS address of the register of the downstream device, and the second box indicates the meter reading length (not more than 64), for example 1000 2a 数据区, indicates to start meter reading from the downstream device address 1000H, the address length is 2a (hexadecimal).

- Parameter area

The parameter area can be selected from the drop-down. The data in the parameter area can be uploaded to the server once when the device is powered on, once a day, or when the data changes.

- Alarm word

setting 10 alarm words of addresses can be set, and data will be uploaded when the alarm word of the set address changes.

- Number of equipment

The number of meter readings is set, and the data collection of up to 30 MODBUS RTU devices is supported.

- Number of meter reading segments

The number of register address fields collected by each MODBUS device shall not exceed 5.

- Number of alarm segments

The total number of alarm words to be set is up to 10, and the number of settings should be consistent with the number of alarm words.

- Waiting time

Wait for the response time of the downstream device.

- Number of timeouts

If the number of reconnections of the downlink device exceeds the specified number, it is considered that the downlink device is disconnected from the AWT100 wireless communication terminal.

- Downlink

The default 485 bus communication (LoRa communication is optional).

- Downstream device address type

Use the MODBUS address to read the meter and the serial number (14-digit) address to read the meter.

- Downstream equipment type (Reserved) (4) AWT100-2G/4G/NB wireless communication terminal network setting parameters

抄表设置	网络设置	协议设置	下行设备状态	MQTT	中继/透传	
IP_1地址:	121 196 207 228	设备号:	ZHYDTEST000001		连接方式:	IP地址
IP_1端口:	6879	数据上传间隔:	5	Min	TCP连接总数:	1
IP_2地址:	0 0 0 0	参数上传间隔:	1440	分	网络超时时间:	10 s
IP_2端口:	0				网络超时重试次数:	2
域名设置_1:	www.acrel.com					
域名设置_2:	www.acrel.com					

- IP\_1 address  
The IP address of the first server to connect to.
- IP\_1 port  
Connect the IP port of the first server.
- IP\_2 address  
Connect to the IP address of the second server.
- IP\_2 port  
Connect the IP port of the second server.
- Domain name  
setting\_1 The domain name of the first server to connect to.
- Domain name setting\_2  
The domain name of the second server to connect to.
- Device number  
Device serial number (14 digits).
- Data upload interval  
The data upload time interval in the data area, the default is 5min.
- Parameter upload interval  
The data upload time interval in the data area, the default is 1440min.
- Connection method  
The connection address method with the service area (IP/domain name).
- Total number of TCP connections  
The number of servers connected at the same time.
- Network timeout  
The time to wait for a response from the server.
- Number of network timeout retries  
The number of retransmissions to the server.

(5) AWT100-2G/4G/NB wireless communication terminal protocol setting parameters

抄表设置	网络设置	协议设置	下行设备状态	MQTT	中继/透传
编码因子1:	<input type="text"/>	ST:	53	通信协议选项:	安全用电
编码因子2:	<input type="text"/>	MN:	00000000000000000000000000000000 num:24	协议内部选项:	无序序号
编码分类:	t				
工艺编码表:	1				



- Coding factor 1
  - Coding factor 2
  - Code classification
  - Process coding
  - ST
  - MN
  - Communication protocol options
  - Protocol internal options
- The above are the relevant agreement parameters involved in each area of the HJ212 environmental protection agreement, which depends on the agreement.

(6) Downlink device status of AWT100-2G/4G/NB wireless communication terminal



• Downlink device status

Click can read the status of all downstream devices .Click can read the status of a single downstream device.Click can write the serial number of the downstream device (when using the MODBUS address to read the meter,there is no need to write the serial number).■Red indicates that the downstream device is offline.■Green indicates that the downstream device is online .E.g 1: .Indicates that the device with the serial number 20190903000001 is online.

(7) AWT100-LoRa Wireless communication terminal relay/transmission parameters

Relay/transparent transmission setting options are used to set the wireless parameter settings of the AWT100-LoRa wireless communication terminal , Click the button can read the wireless parameter settings of the AWT100-LoRa wireless communication terminal. After modifying the wireless parameters of the AWT100-LoRa wireless communication terminal , Click the button to complete parameter setting。



- Relay transmission frequency

The frequency of relay transmission: 460 ~ 510MHz.If the working mode of the AWT100-LoRa wireless communication terminal is set to relay mode, the relay transmission frequency must be inconsistent with the transparent transmission frequency.

- Transparent transmission frequency

The frequency of transparent transmission: 460~510MHz.

- Expansion factor

LoRa spreading factor

- Signal bandwidth

LoRa signal bandwidth

- Type

Set the working mode of the AWT100-LoRa wireless communication terminal.There are two ways to choose from: transparent transmission and relay.

### (8) AWT100-GPS positioning module parameter settings

Positioning interval: latitude and longitude refresh interval.

Positioning time: positioning satellite time.

AWT_GPS modbus register address table and description					
Adress	Register number	name	Number of registers	Attributes(W/R)	Description
0000H	1	contact address	1	W/R	Value range 1~127, universal address 0
0001H	2	Baud rate	1	W/R	0:1200 1:2400 2:4800 3:9600 4:19200 5:38400 6:57600 7:115200
0002H	3	Positioning interval	1	W/R	Value range 100ms~10000ms
0003H	4	Latitude hemisphere	1	R	ASCIICode (0x4E)N,Northern Hemisphere (0x53)S, Southern Hemisphere
0004H	5	latitude	2	R	E.g 3150.7797 -> 31°50'.7797
0005H	6				
0006H	7	Transhemisphere	1	R	ASCII Code (0x45)E,Eastern Hemisphere (0x57)W, Western Hemisphere
0007H	8	longitude	2	R	float E.g 11711.9287 -> 117°11'.9286
0008H	9				
0009H	10	Second Minute	1	R	UTC time
000AH	11	Hour	1	R	
		Day			

000BH	12	Month	1	R	
		Year			

[Note] 1. Modbus read and write reply delay is 300ms~500ms under the default baud rate of 9600, Therefore, the waiting time of Modbus host should be at least more than 300ms;

(9)AWT100-WiFiWireless communication module parameter setting



WIFI

AP:

PASS:

AP: WIFI hotspot name

PASS: WIFI hotspot password

(10)AWT100-CEEthernet data conversion module parameter setting

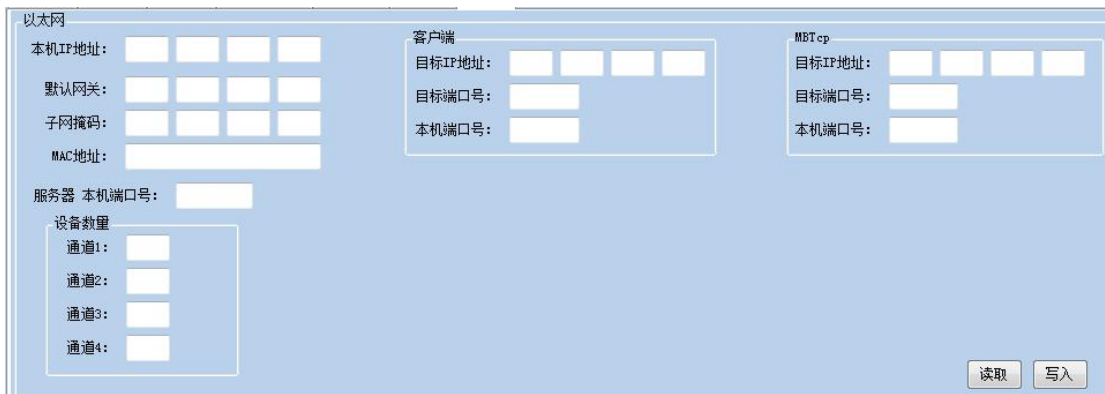

以太网

本机IP地址:

默认网关:

子网掩码:

MAC地址:

服务器 本机端口号:

设备数量

通道1:

通道2:

通道3:

通道4:

客户端

目标IP地址:

目标端口号:

本机端口号:

MBTcp

目标IP地址:

目标端口号:

本机端口号:

(11)AWT100-DP data conversion module parameter setting



关闭串口 COM8

常规参数

输入参数区

输出参数区

Profibus地址  波特率  停止位

校验方式

响应等待时间  ms 抄表段数量  1-80

轮询延时间  ms 输出段数量  1-80

重发次数

软件编号  序列号

软件版本号  订单号

本地时间  仪表时间

## **8 How to use**

After setting the parameters of the AWT100 wireless communication terminal, confirm that the downlink equipment is operating normally and the gateway can communicate with the AWT100 wireless communication terminal normally. Wait for the AWT100 wireless communication terminal to establish a connection with the server, and send the device number to the server to distinguish the devices. At the same time, the AWT100 wireless communication terminal will poll the downstream device to query the online downstream device according to the set query address range and query register address field, and send the polled data to the server for reporting.